



GROUNDPIECE *ANTONIO CITTERIO* **2001**

DIVANI

GROUNDPIECE | ANTONIO CITTERIO | 2001

Struttura elementi in metallo con imbottitura in poliuretano stampato rivestita in tessuto protettivo accoppiato

Struttura pouf in legno massello con imbottitura in poliuretano espanso rivestita in tessuto protettivo accoppiato

Cuscini seduta in piuma d'oca sterilizzata (certificata Assopiuma, etichetta oro) con inserto in materiale indeformabile o in poliuretano espanso e dacron. Seduta premium in piuma d'oca sterilizzata (certificata Assopiuma, etichetta oro) con inserto in materiale indeformabile ad alta resilienza

Cuscini schienale in piuma d'oca sterilizzata (certificata Assopiuma, etichetta oro) con o senza rullo reggicuscino in poliuretano espanso. I cuscini schienale sono a richiesta con supplemento di prezzo

Bracciolo 'tessuto 24' in metallo con imbottitura in poliuretano stampato rivestito in tessuto protettivo accoppiato

Bracciolo 'tessuto 12' in legno massello con imbottitura in poliuretano espanso rivestito in tessuto protettivo accoppiato

Bracciolo cuoio in metallo rivestito in cuoio nei colori: grigio 5003, testa di moro 5004, testa di moro scuro 5013, nero 5005, oliva 5006, rosso bulgaro 5008, sabbia 5001, tabacco 5015, scamosciato moro 6004, scamosciato nero 6005, scamosciato oliva 6003, scamosciato sabbia 6001

Piedi in metallo verniciato a forno con polveri epossidiche. Appoggio a terra su puntali in materiale termoplastico

Rivestimento sfoderabile sia nella versione in tessuto che nella versione in pelle

COD. 011M11 ELEMENTO

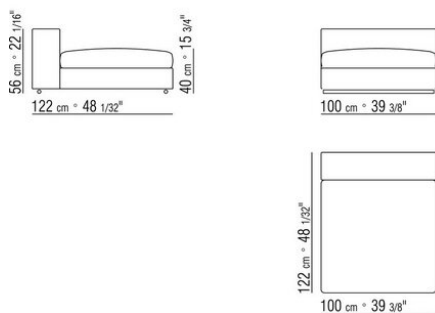

COD. 011M06 ELEMENTO

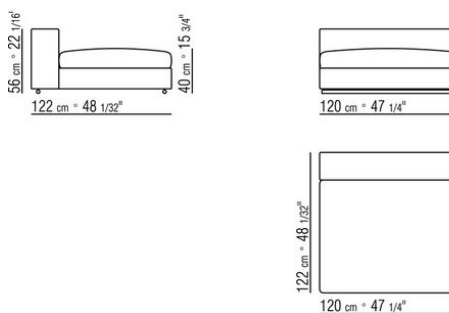

COD. 011M08 ELEMENTO

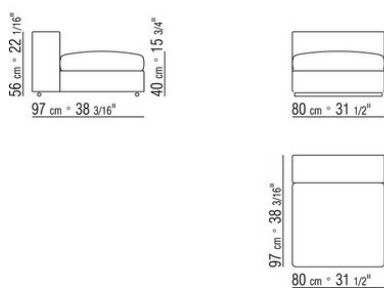

COD. 011M09 ELEMENTO

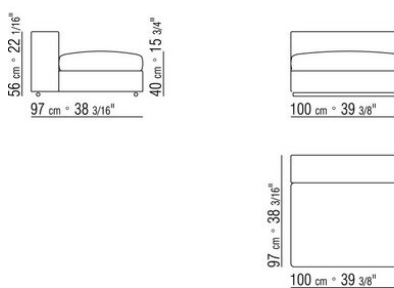

COD. 011M10 ELEMENTO

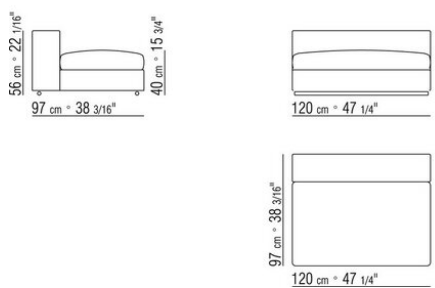

COD. 011M02 ELEMENTO

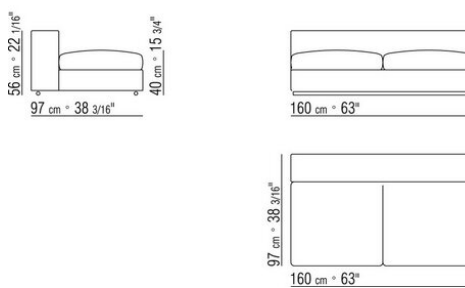

COD. 011M03 ELEMENTO

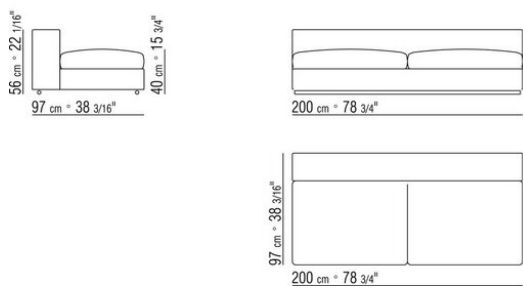

COD. 011M04 ELEMENTO

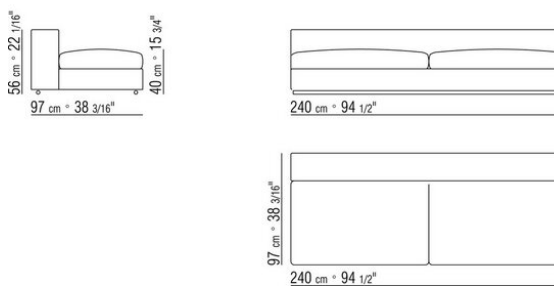

COD. 011M34 ELEMENTO

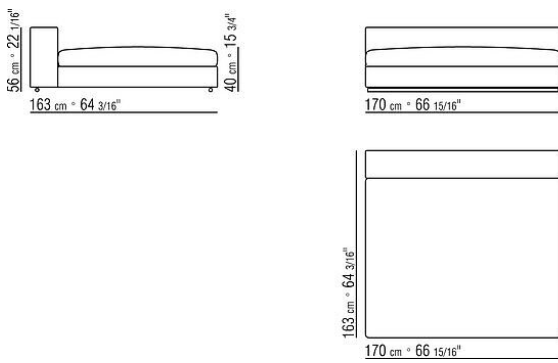

COD. 011M21 ELEMENTO / DACRON

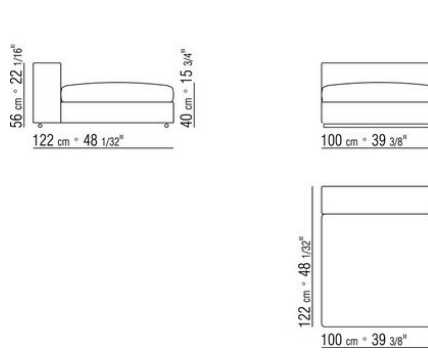

COD. 011M16 ELEMENTO / DACRON

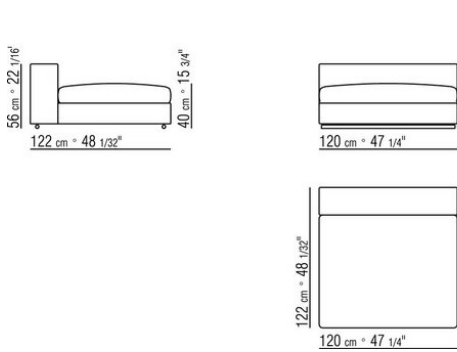

COD. 011M18 ELEMENTO / DACRON

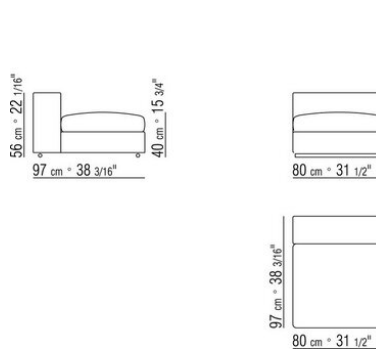

COD. 011M19 ELEMENTO / DACRON

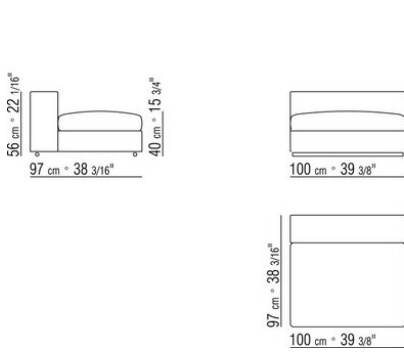

COD. 011M20 ELEMENTO / DACRON

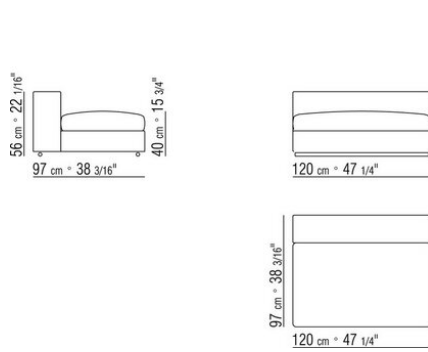

COD. 011M12 ELEMENTO / DACRON

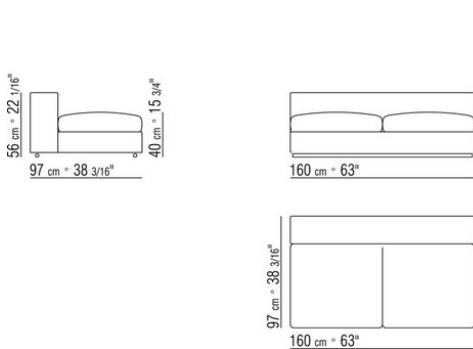

COD. 011M13 ELEMENTO / DACRON

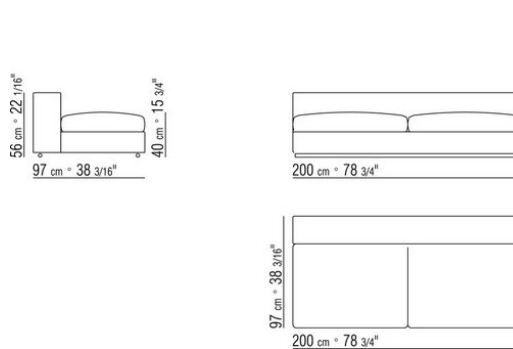

COD. 011M14 ELEMENTO / DACRON

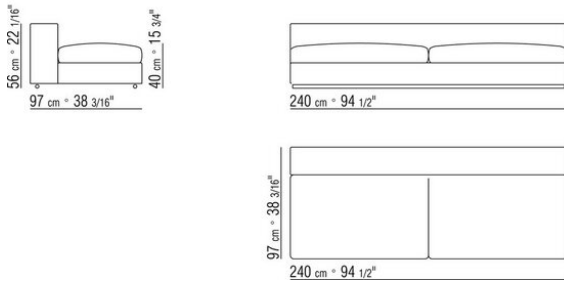

COD. 011M38 ELEMENTO / DACRON

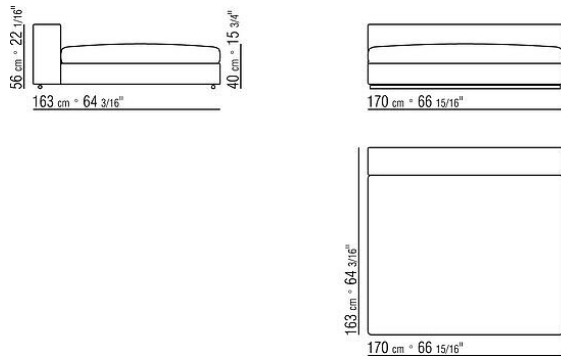

COD. 011MA3 ELEMENTO / PREMIUM

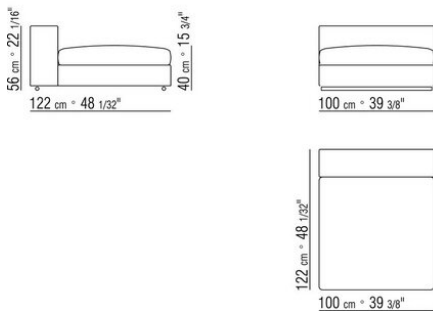

COD. 011MA5 ELEMENTO / PREMIUM

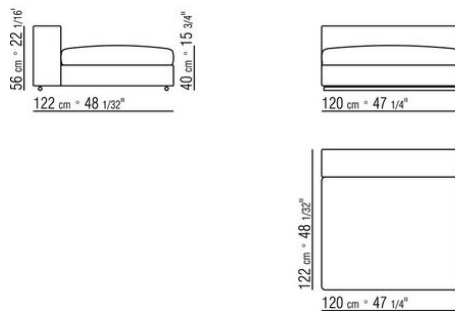

COD. 011MA1 ELEMENTO / PREMIUM

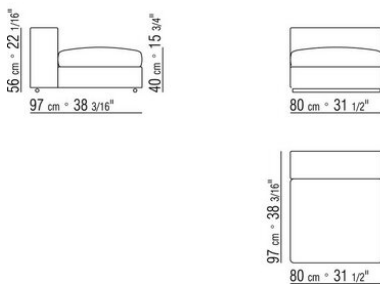

COD. 011MA2 ELEMENTO / PREMIUM

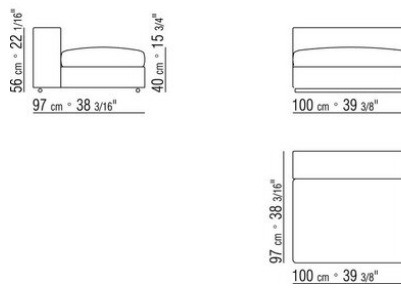

COD. 011MA4 ELEMENTO / PREMIUM

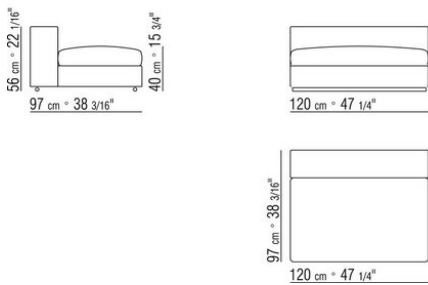

COD. 011MA6 ELEMENTO / PREMIUM

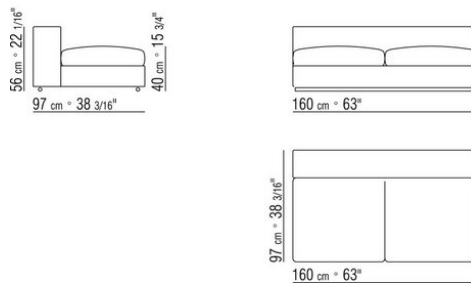

COD. 011MA7 ELEMENTO / PREMIUM

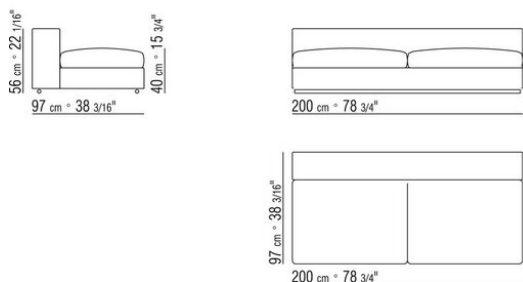

COD. 011MA8 ELEMENTO / PREMIUM

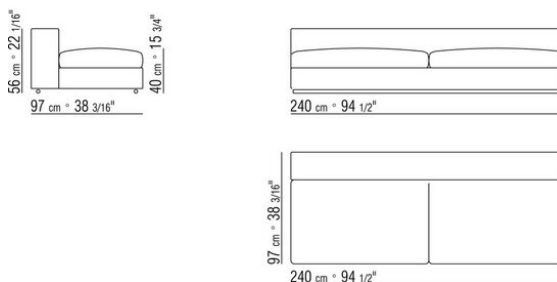

COD. 011MA9 ELEMENTO / PREMIUM

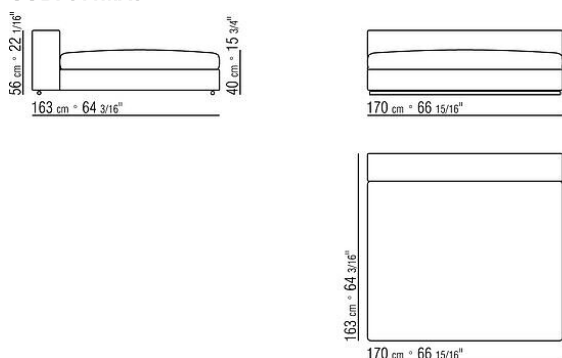

COD. 011M70 BRACCIOLO

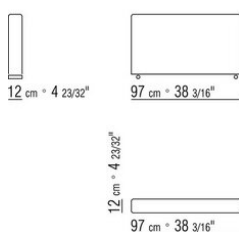

COD. 011M71 BRACCIOLO

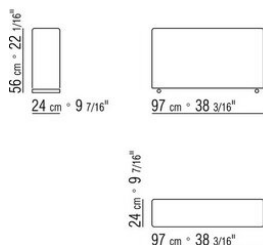

COD. 011M72 BRACCIOLO

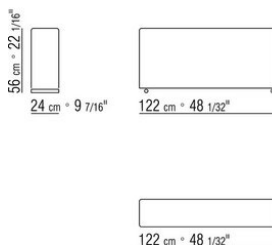

COD. 011M73 BRACCIOLO

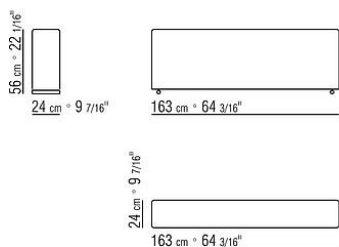

COD. 011M93 CUSCINO

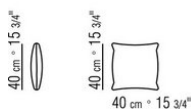

COD. 011M92 CUSCINO

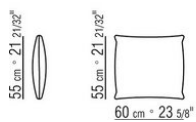

COD. 011M99 CUSCINO

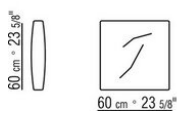

COD. 011M95 CUSCINO C/RULLO

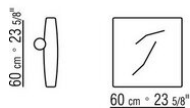

COD. 011M94 CUSCINO

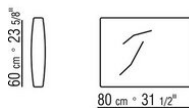

COD. 011M97 CUSCINO C/RULLO

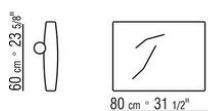

COD. 011M98 CUSCINO

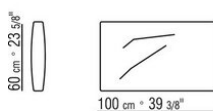

COD. 011M96 CUSCINO C/RULLO

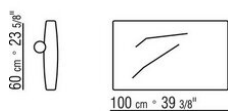

COD. 011M52 POUF

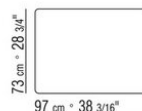
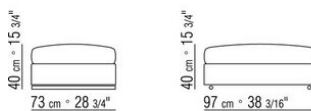

COD. 011M51 POUF

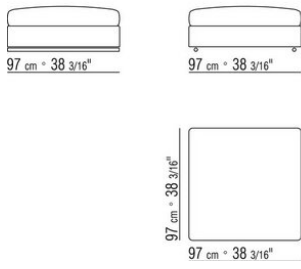

COD. 011M50 POUF

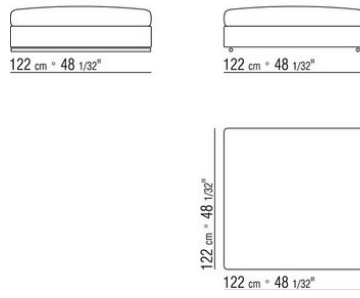

COD. 011M56 POUF /DACRON

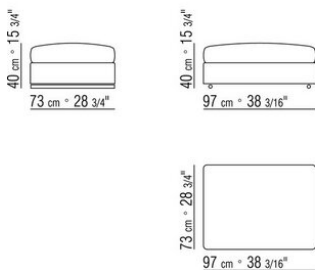

COD. 011M55 POUF /DACRON

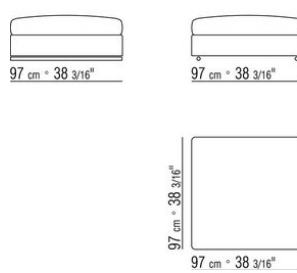

COD. 011M54 POUF /DACRON

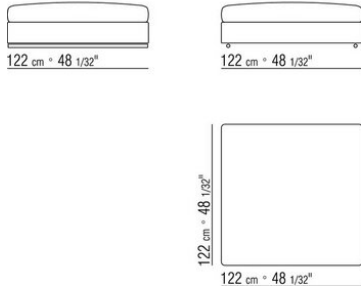

COD. 011MB3 POUF PREMIUM

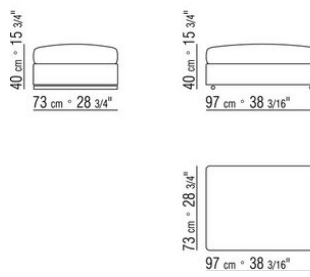

COD. 011MB2 POUF PREMIUM

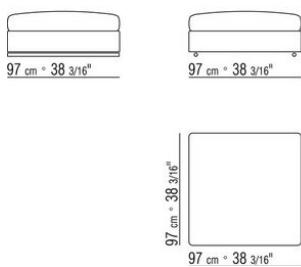

COD. 011MB1 POUF PREMIUM

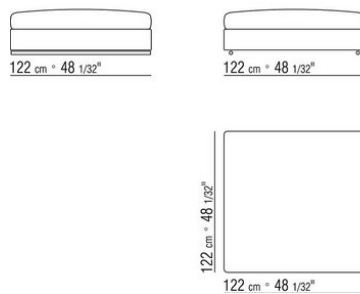

COD. 011M22 POUF C/SCHIENALE

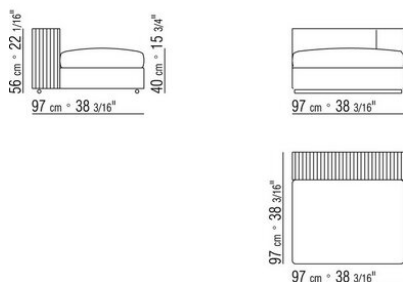

COD. 011M23 POUF C/SCHIENALE

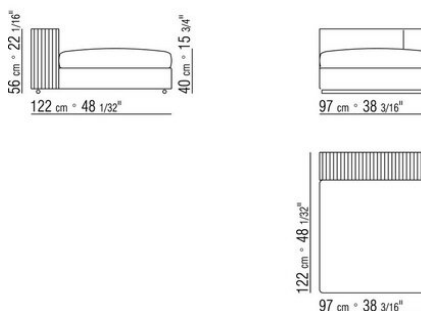

COD. 011M32 POUF /DACRON C/SCHIEN.

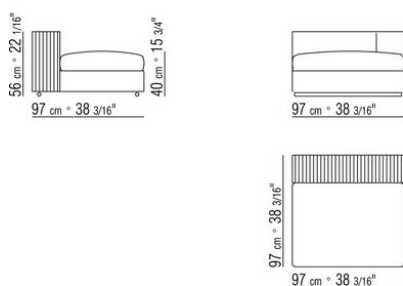

COD. 011M33 POUF /DACRON C/SCHIEN.

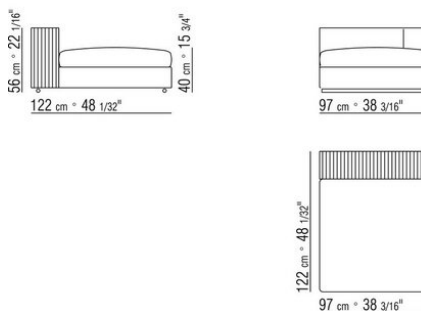

COD. 011MB4 POUF PREMIUM C/SCHIENALE

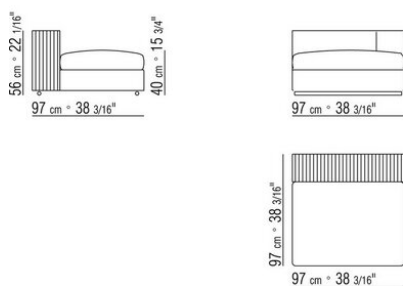

COD. 011MB5 POUF PREMIUM C/SCHIENALE

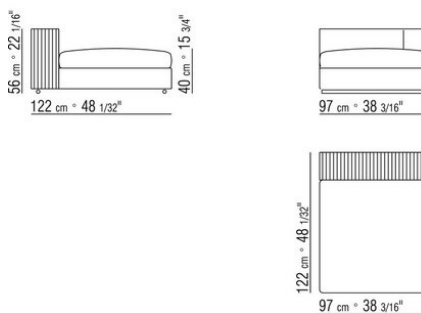

COD. 011M77 BRACCILO CUOIO

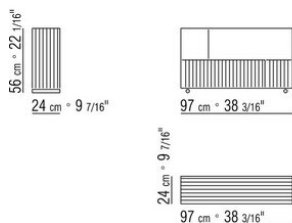

COD. 011M79 BRACCILO SX / CUOIO

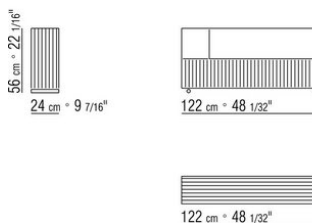

COD. 011M74 BRACCIOLO CUIOIO

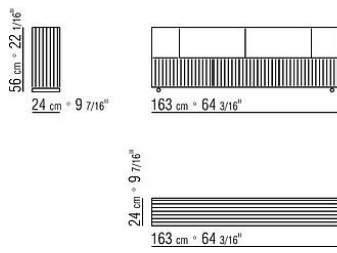

011MXA

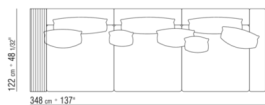

- N.1 COD.011M79 - BRACCIOLO SX / CUIOIO CM.122 x24
- N.1 COD.011M72 - BRACCIOLO CM.122 x24
- N.3 COD.011M11 - ELEMENTO CM.100 x122
- N.2 COD.011M99 - CUSCINO CM.60 x60
- N.3 COD.011M97 - CUSCINO C/RULLO CM.80 x60
- N.2 COD.011M93 - CUSCINO CM.40 x40
- N.1 COD.011M92 - CUSCINO CM.60 x55

011MXB

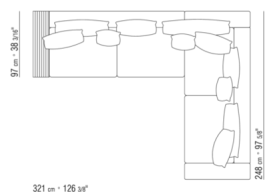

- N.1 COD.011M77 - BRACCIOLO CUIOIO CM.97 x24
- N.2 COD.011M71 - BRACCIOLO CM.97 x24
- N.2 COD.011M03 - ELEMENTO CM.200 x97
- N.2 COD.011M99 - CUSCINO CM.60 x60
- N.2 COD.011M95 - CUSCINO C/RULLO CM.60 x60
- N.2 COD.011M97 - CUSCINO C/RULLO CM.80 x60
- N.1 COD.011M96 - CUSCINO C/RULLO CM.100 x60
- N.3 COD.011M93 - CUSCINO CM.40 x40
- N.1 COD.011M92 - CUSCINO CM.60 x55

011MXC

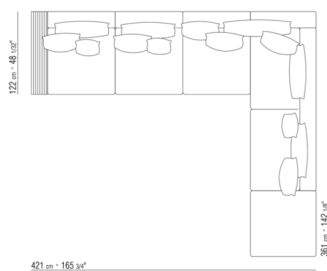

- N.1 COD.011M79 - BRACCIOLO SX / CUIOIO CM.122 x24
- N.1 COD.011M71 - BRACCIOLO CM.97 x24
- N.3 COD.011M11 - ELEMENTO CM.100 x122
- N.1 COD.011M04 - ELEMENTO CM.240 x97
- N.1 COD.011M51 - POUF CM.97 x97
- N.2 COD.011M99 - CUSCINO CM.60 x60
- N.1 COD.011M95 - CUSCINO C/RULLO CM.60 x60
- N.4 COD.011M97 - CUSCINO C/RULLO CM.80 x60
- N.1 COD.011M96 - CUSCINO C/RULLO CM.100 x60
- N.3 COD.011M93 - CUSCINO CM.40 x40
- N.3 COD.011M92 - CUSCINO CM.60 x55

011MXD

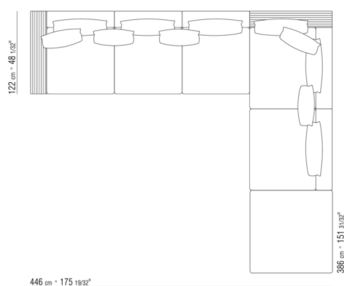

- N.2 COD.011M79 - BRACCIOLO SX / CUIOIO CM.122 x24
- N.3 COD.011M11 - ELEMENTO CM.100 x122
- N.2 COD.011M06 - ELEMENTO CM.120 x122
- N.1 COD.011M50 - POUF CM.122 x122
- N.6 COD.011M97 - CUSCINO C/RULLO CM.80 x60
- N.2 COD.011M99 - CUSCINO CM.60 x60
- N.3 COD.011M92 - CUSCINO CM.60 x55

011MXF

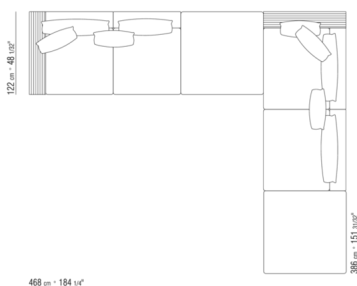

- N.2 COD.011M79 - BRACCIOLO SX / CUIOIO CM.122 x24
- N.2 COD.011M11 - ELEMENTO CM.100 x122
- N.2 COD.011M06 - ELEMENTO CM.120 x122
- N.2 COD.011M50 - POUF CM.122 x122
- N.3 COD.011M97 - CUSCINO C/RULLO CM.80 x60
- N.1 COD.011M95 - CUSCINO C/RULLO CM.60 x60
- N.2 COD.011M99 - CUSCINO CM.60 x60
- N.3 COD.011M92 - CUSCINO CM.60 x55

011MXG

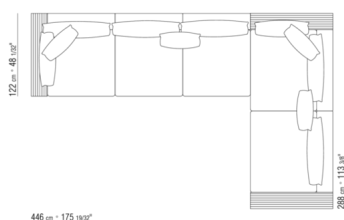

- N.2 COD.011M79 - BRACCIOLO SX / CUIOIO CM.122 x24
- N.3 COD.011M11 - ELEMENTO CM.100 x122
- N.2 COD.011M06 - ELEMENTO CM.120 x122
- N.1 COD.011M78 - BRACCIOLO CUIOIO CM.122 x24
- N.5 COD.011M97 - CUSCINO C/RULLO CM.80 x60
- N.2 COD.011M95 - CUSCINO C/RULLO CM.60 x60
- N.2 COD.011M99 - CUSCINO CM.60 x60
- N.2 COD.011M92 - CUSCINO CM.60 x55

011MXH



- N.1 COD.011M79 - BRACCIOLO SX / CUIOIO CM.122 x24
- N.2 COD.011M23 - POUF C/SCHIENALE CM.97 x122
- N.2 COD.011M50 - POUF CM.122 x122
- N.2 COD.011M97 - CUSCINO C/RULLO CM.80 x60
- N.1 COD.011M99 - CUSCINO CM.60 x60
- N.2 COD.011M92 - CUSCINO CM.60 x55
- N.1 COD.011M93 - CUSCINO CM.40 x40
- N.1 COD.012P96 - BRACCIOLO A RULLO CM.66 x20

Service

Progetta i tuoi spazi Flexform con AccaDueHome:

Come **rivenditore Flexform**, mettiamo la nostra esperienza di interior design al tuo servizio, per arredare la tua casa e creare ambienti d'atmosfera, curati in ogni dettaglio.

Il divano Groundpiece di Flexform è disponibile in differenti configurazioni, misure e rivestimenti che puoi personalizzare. Ti guidiamo attraverso ogni fase dell'acquisto: dalla consulenza iniziale alla scelta delle finiture, fino alla consegna.

Per ricevere un preventivo con un prezzo dedicato contattaci o visita la **Pagina Dedicata sul sito AccaDueHome**. Grazie alla nostra partnership con Flexform, avrai accesso a condizioni economiche dedicate.

Contattaci e inizia il tuo progetto:

info@accaduehome.com | Tel. +39 0721 430392

Design your Flexform spaces with AccaDueHome.

As an authorized **Flexform dealer**, we place our interior design expertise at your service to furnish your home and create evocative atmospheres, curated in every detail. The Groundpiece sofa by Flexform is available in a wide range of bespoke configurations, sizes, and upholstery options for full customization. We guide you through every stage of your journey: from the initial consultation and material selection to final delivery. To receive a personalized quote with exclusive pricing, please contact us or visit the **dedicated page on the AccaDueHome website**. Thanks to our partnership with Flexform, you will benefit from dedicated commercial conditions.

Contact us and start your project:

info@accaduehome.com | Tel. +39 0721 430392