Hybrid

DIVANI 2020

Antonio Citterio



Descrizione

Hybrid è un sistema di sedute modulare estremamente versatile e dalla componibilità pressoché infinita. Ruolo chiave nel progetto ha la dimensione tessile che riveste completamente la generosa imbottitura, assoluta protagonista, entrambi elementi tipici dell'indoor, che con Hybrid arrivano con determinazione nell'outdoor. Da qui il nome della collezione, che si propone come vero e proprio anello di congiunzione tra l'interno e l'esterno della casa. Hybrid rappresenta infatti il perfetto elemento d'arredo per climi e spazi che si definiscono nella continuità tra dentro e fuori, ambienti naturalmente aperti a una dimensione en-plein-air, ma anche spazi living integrati a terrazze o giardini. L'unione degli opposti non avviene soltanto attraverso la vista, bensì anche col tatto: Hybrid garantisce infatti nell'outdoor il comfort tipico dei tradizionali imbottiti da interni, grazie a una seduta a materasso, estremamente soffice e accogliente. La cuscineria è realizzata con materiale per imbottiture a diversa densità, studiato per accogliere piacevolmente il corpo e sostenerlo allo stesso tempo, senza sprofondare. Le strutture portanti sono pressoché invisibili e la seduta sembra fluttuare a pochi centimetri dal pavimento. Per garantire ulteriore comodità alla seduta più profonda, lo schienale basso si può innalzare con un cuscino poggiatesta supplementare.

Informazioni tecniche

Struttura

pressofusione ed estrusi d'alluminio con verniciatura a polvere poliestere

Imbottitura

poliuretano sagomato a densità differenziata, fodera in fibra di poliestere con trattamento idrorepellente

Doghe seduta

fibra di vetro

Puntali

materiale termoplastico

Telo di copertura impermeabile

tessuto PES monospalmato su un lato PU

Rivestimento

tessuto in categorie limitate (con profilo)

9HY222

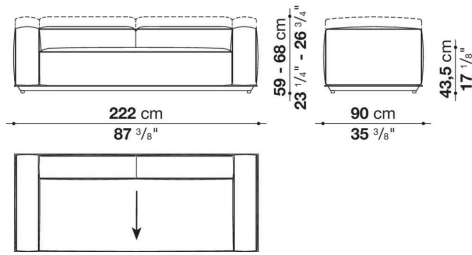

9HY310

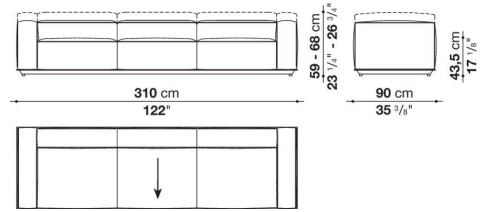

9HY178C

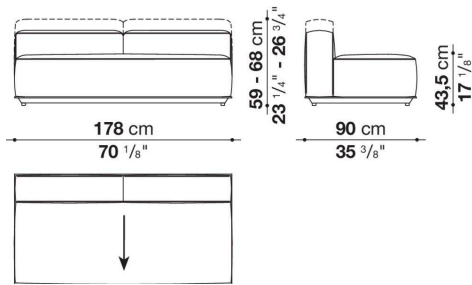

9HY266C

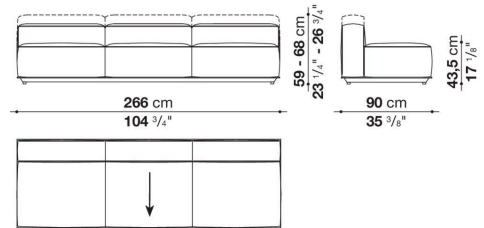

9HY178PA

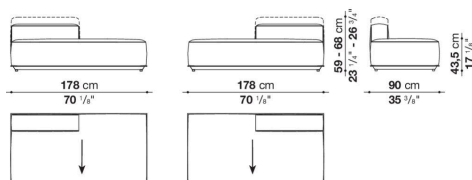

9HY200T_1

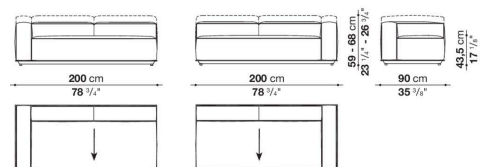

9HY200T_2

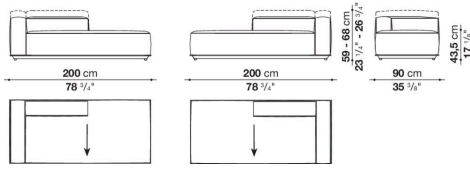

9HY178A_1

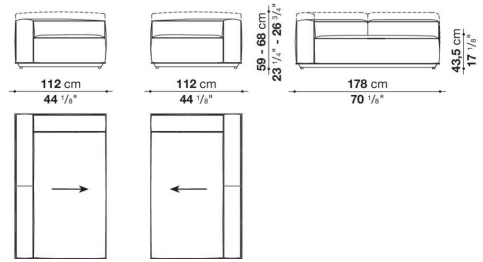

9HY178A_2

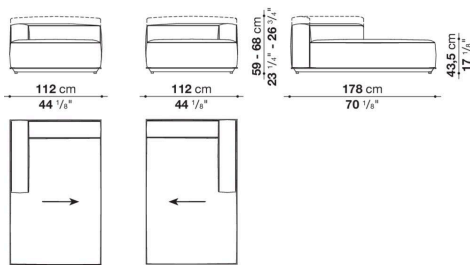

HY178C

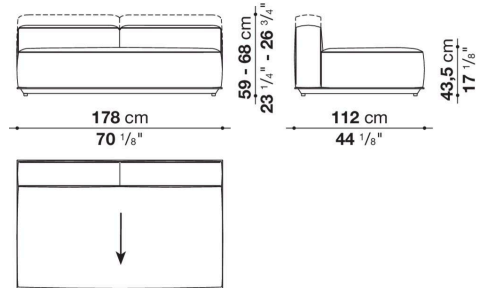

HY266C

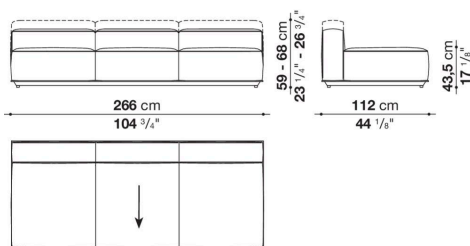

HY178PA

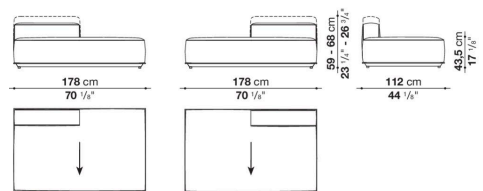

HY200T_1

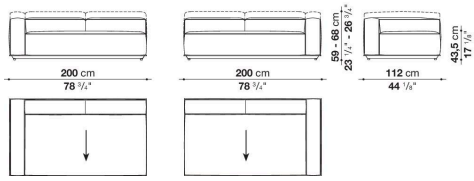

HY200T_2

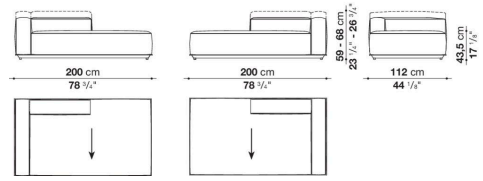

HY222A_1

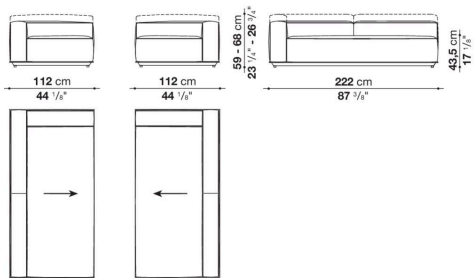

HY222A_2

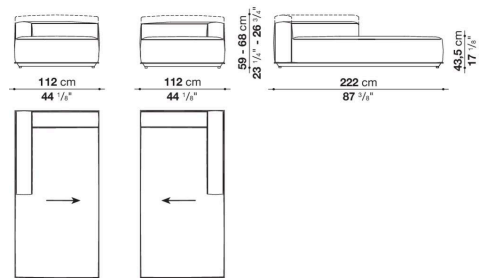

HY134L

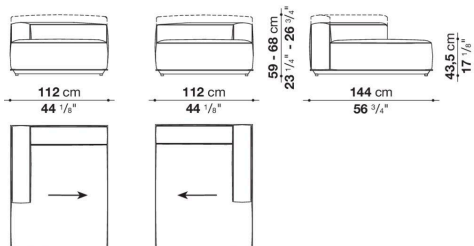

HY134L_2

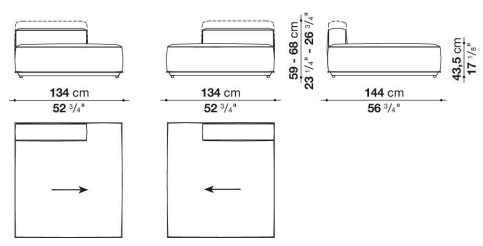

HY200L

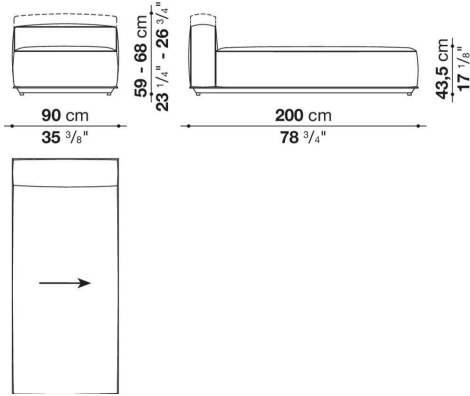

HY90P

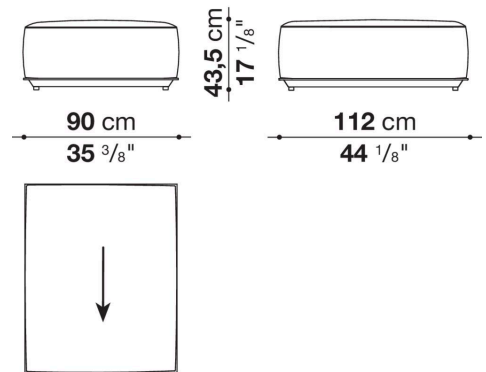

9HY112P

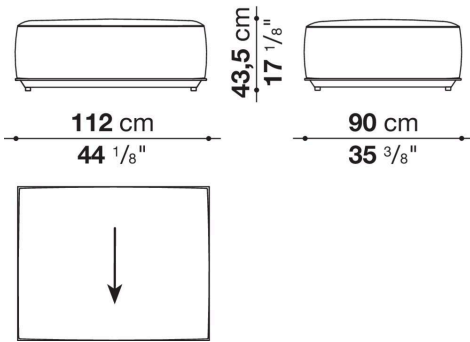

HY134PQ

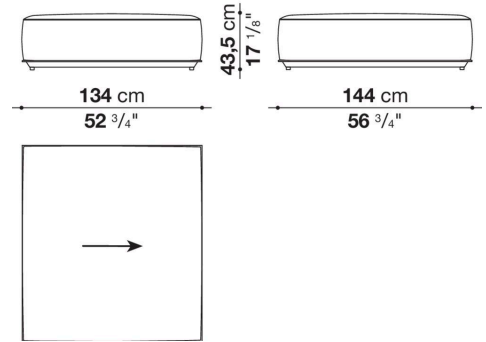

9HY178P

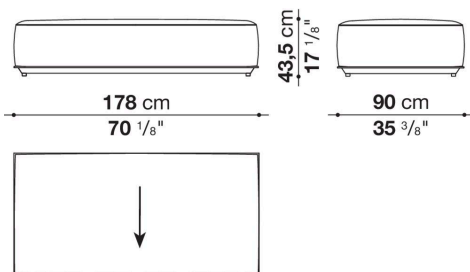

HY178P

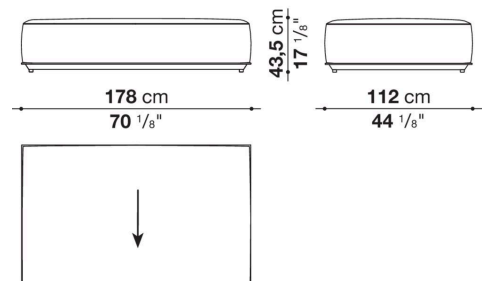

Composizioni

HY001

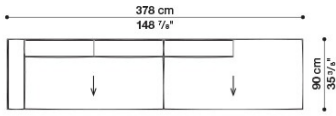

01

HY002

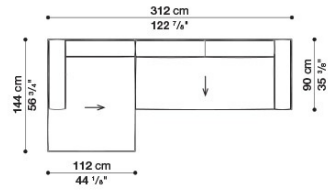

02

HY003

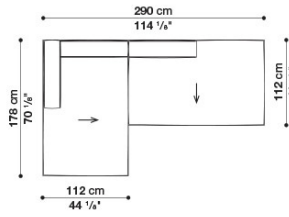

03

HY004

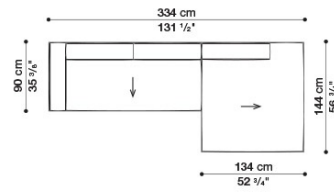

04

HY005

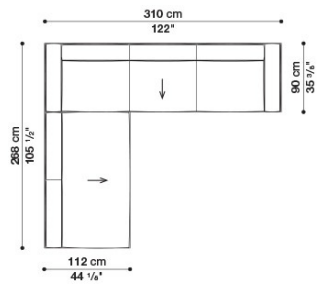

05

HY006

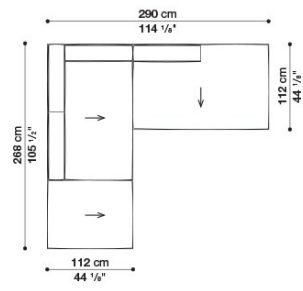

06

HY007

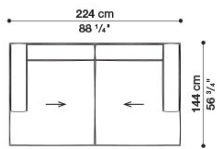

07

HY008

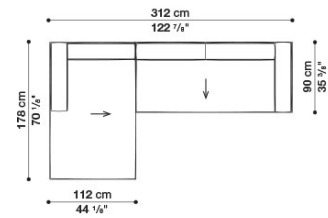

08